

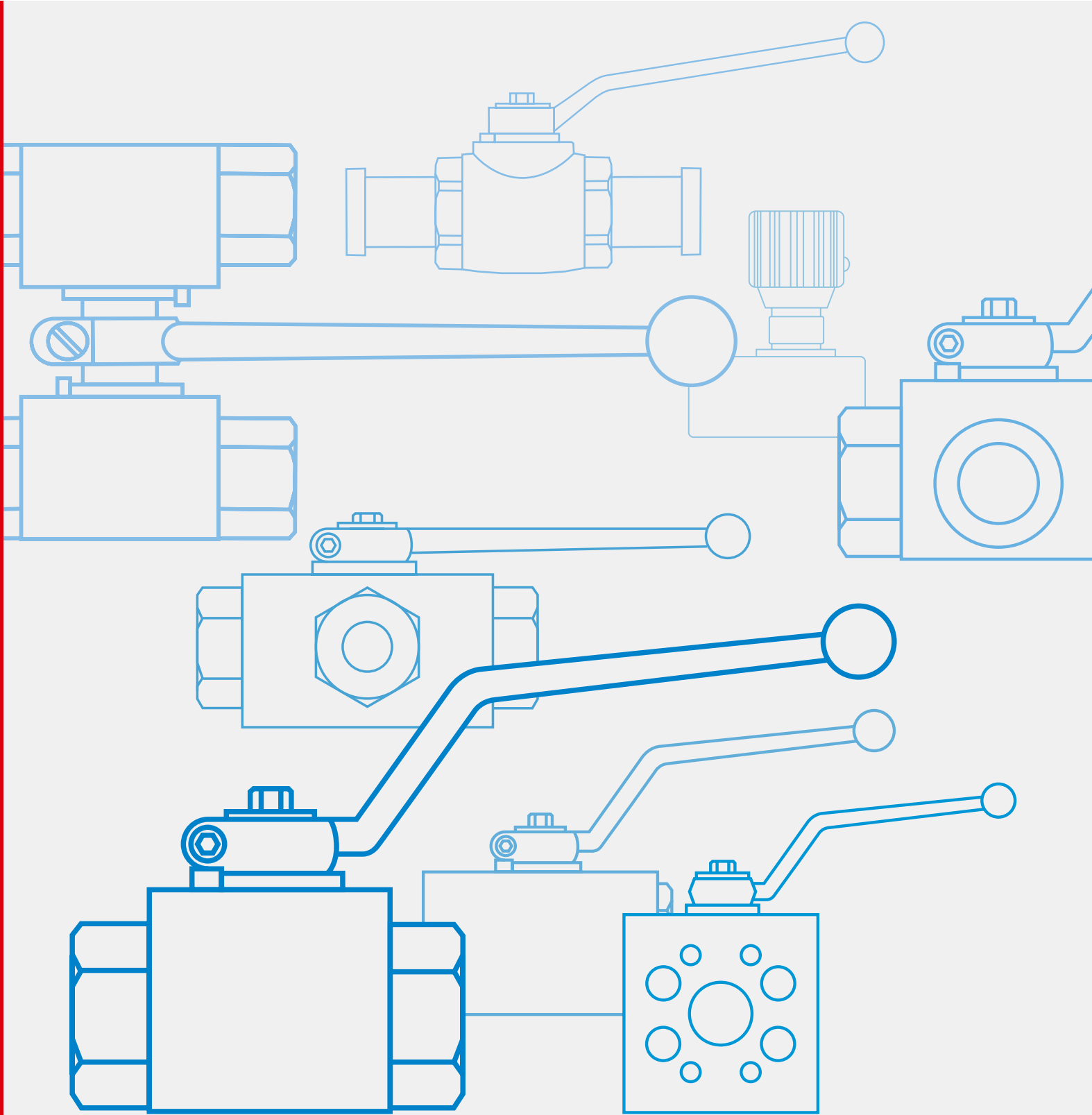

MHA ZENTGRAF
FlowControl Technology



Ball valve with SAE adapter metric / UNC Steel

BKH / BKHP-SAE

Two-way

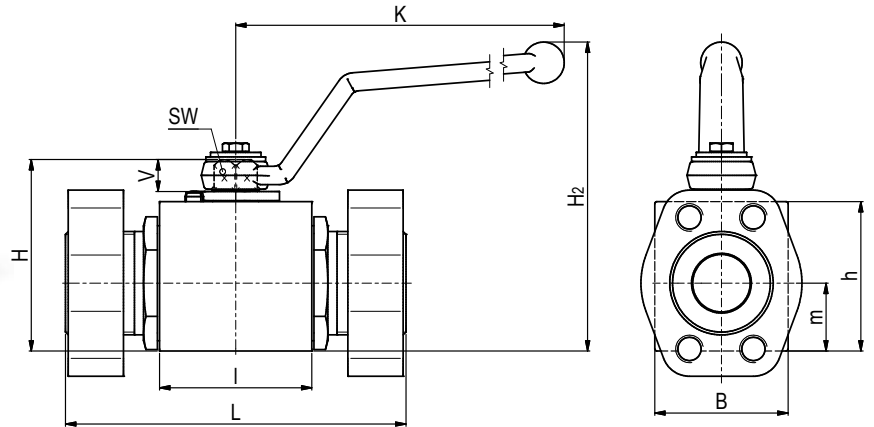
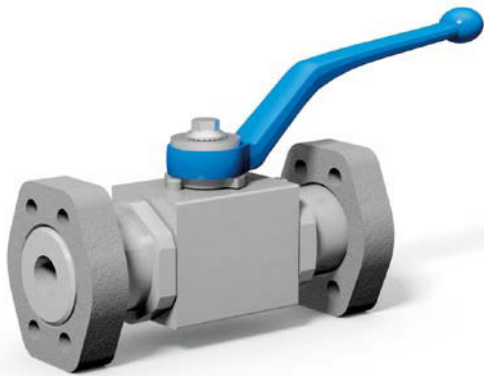

AVAILABLE SIZES

DN13 - DN25 (1/2" to 1")

CONNECTIONS

ISO 6162-1, ISO 6162-2

ACCESSORIES ON REQUEST

- Locking devices page 226 - 229
- Actuators 224 - 225
- Mounting holes 17
- Position switches 232 - 233
- Combinations 188 - 190
- Detent on request

MATERIAL CODE DESCRIPTION

Materials	112A	1128
Body	Steel	Steel
Ball	Steel	Steel
Stem	Steel	Steel
Ball seats	POM	POM
O-rings	NBR	FPM
Tmin /Tmax	-20°C / 100°C	-20°C / 100°C

GENERAL DIMENSIONS

Type	L	B	H	h	m	V	SW	K	H ₂	Lever
BKH-DN13	48	35	54	40	19	11	9	115	89	Zn
BKH-DN20	62	49	75	57	24,5	14	14	171	127	St
BKH-DN25	66	58	83	65	29,5	14	14	171	135	St
BKHP-DN25	74	70	88	70	34,5	14	14	171	140	St

Please note the pressure ratings of the connection flanges!

Ball valve with SAE adapter metric / UNC Steel

BKH / BKHP-SAE

CONNECTION TYPE	DIMENSIONS											ORDER CODE PER MATERIAL COMBINATION		
	Type	LW	L	B ₁	b ₁	t	a	b	M	Weight [Kg]	PN [bar]	112A	1128	
	BKH-DN13-SAE210	13	120	48	56	13	17,5	38,1	M8	1,50	350	32986	30024	
	BKH-DN20-SAE210	20	136	50	65	14	22,2	47,6	M10	3,00	350	30124	29967	
	BKH-DN25-SAE210	25	148	60	70	16	26,2	52,4	M10	4,50	315	23290	30025	
	BKH-DN13-SAE210	13	120	48	56	13	17,5	38,1	5/16" UNC	1,50	350	37789	37790	
	BKH-DN20-SAE210	20	136	50	65	14	22,2	47,6	3/8" UNC	3,00	350	37791	37792	
	BKH-DN25-SAE210	25	148	60	70	16	26,2	52,4	3/8" UNC	4,50	315	37793	37794	

CONNECTION TYPE	DIMENSIONS											ORDER CODE PER MATERIAL COMBINATION		
	Type	LW	L	B ₁	b ₁	t	a	b	M	Weight [Kg]	PN [bar]	112A	1128	
	BKH-DN13-SAE420	13	120	48	56	16	18,2	40,5	M8	1,50	420	32988	37584	
	BKH-DN20-SAE420	20	136	60	71	19	23,8	50,8	M10	2,75	420	25407	37585	
	BKH-DN25-SAE420	25	148	70	81	24	27,8	57,2	M12	3,80	315	25408	37586	
	BKHP-DN25-SAE420	25	156	70	81	24	27,8	57,2	M12	4,50	420	49285	53456	
	BKH-DN13-SAE420	13	120	48	56	16	18,2	40,5	5/16" UNC	1,50	420	37795	37796	
	BKH-DN20-SAE420	20	136	60	71	19	23,8	50,8	3/8" UNC	2,75	420	37797	37798	
	BKH-DN25-SAE420	25	148	70	81	24	27,8	57,2	7/16" UNC	3,80	315	37799	37800	
	BKHP-DN25-SAE420	25	156	70	81	24	27,8	57,2	7/16" UNC	4,50	420	53457	53458	

Two-way

Ball valve with SAE adapter metric / UNC Stainless Steel

BKH / BKHP-SAE

Two-way

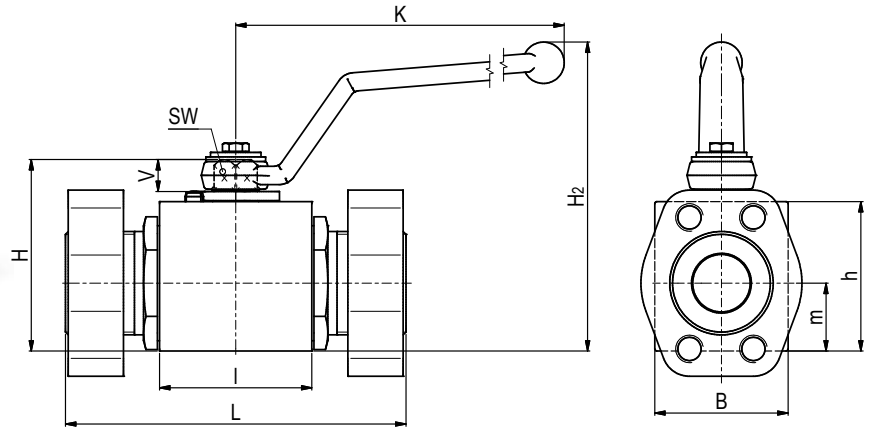
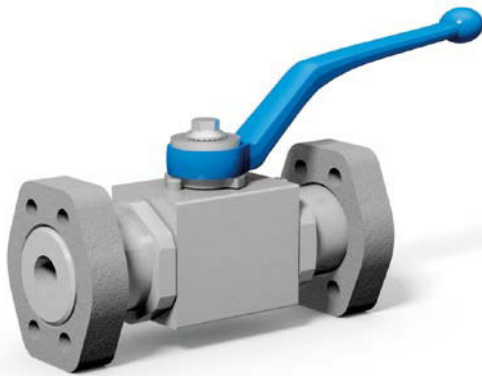

AVAILABLE SIZES

DN13 - DN25 (1/2" to 1")

CONNECTIONS

ISO 6162-1, ISO 6162-2

ACCESSORIES ON REQUEST

- Locking devices page 226 - 229
- Actuators 224 - 225
- Mounting holes 17
- Position switches 232 - 233
- Combinations 188 - 190
- Detent on request

MATERIAL CODE DESCRIPTION

Materials	442A	4428
Body	Stainless Steel	Stainless Steel
Ball	Stainless Steel	Stainless Steel
Stem	Stainless Steel	Stainless Steel
Ball seats	POM	POM
O-rings	NBR	FPM
Tmin /Tmax	-30°C / 100°C	-20°C / 100°C

GENERAL DIMENSIONS

Type	l	B	H	h	m	V	SW	K	H ₂	Lever
BKH-DN13	48	35	54	40	19	11	9	115	89	Zn
BKH-DN20	62	49	75	57	24,5	14	14	171	127	St
BKHP-DN20	82	58	83	65	32,5	14	14	171	135	St
BKH-DN25	66	58	83	65	29,5	14	14	171	135	St
BKHP-DN25	84	70	88	70	34,5	14	14	171	140	St

Please note the pressure ratings of the connection flanges!

Ball valve with SAE adapter metric / UNC Stainless Steel

BKH / BKHP-SAE

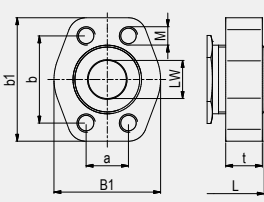
CONNECTION TYPE	DIMENSIONS										ORDER CODE PER MATERIAL COMBINATION		
	Type	LW	L	B ₁	b ₁	t	a	b	M	Weight [Kg]	PN [bar]	442A	4428
	BKH-DN13-SAE210	13	120	48	56	13	17,5	38,1	M8	1,50	350	37587	33949
	BKH-DN20-SAE210	20	136	50	65	14	22,2	47,6	M10	3,00	315	32339	37588
	BKHP-DN20-SAE210	20	156	50	65	14	22,2	47,6	M10	-	350	on request	
	BKH-DN25-SAE210	25	148	60	70	16	26,2	52,4	M10	4,50	315	32340	37589
	BKH-DN13-SAE210	13	120	48	56	13	17,5	38,1	5/16" UNC	1,50	350	37801	37802
	BKH-DN20-SAE210	20	136	50	65	14	22,2	47,6	3/8" UNC	3,00	315	37803	37804
	BKHP-DN20-SAE210	20	156	50	65	14	22,2	47,6	3/8" UNC	-	350	on request	
	BKH-DN25-SAE210	25	148	60	70	16	26,2	52,4	3/8" UNC	4,50	315	37805	37806

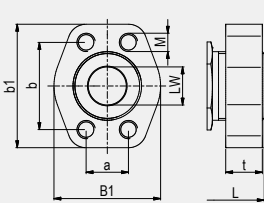
CONNECTION TYPE	DIMENSIONS										ORDER CODE PER MATERIAL COMBINATION		
	Type	LW	L	B ₁	b ₁	t	a	b	M	Weight [Kg]	PN [bar]	442A	4428
	BKH-DN13-SAE420	13	120	48	56	16	18,2	40,5	M8	1,50	420	37590	37591
	BKH-DN20-SAE420	20	136	60	71	19	23,8	50,8	M10	2,75	315	34367	33961
	BKHP-DN20-SAE420	20	156	60	71	19	23,8	50,8	M10	3,59	420	49048	53479
	BKH-DN25-SAE420	25	148	70	81	24	27,8	57,2	M12	3,80	315	35894	37592
	BKHP-DN25-SAE420	25	165	70	81	24	27,8	57,2	M12	5,03	420	49203	53480
	BKH-DN13-SAE420	13	120	48	56	16	18,2	40,5	5/16" UNC	1,50	420	37807	37808
	BKH-DN20-SAE420	20	136	60	71	19	23,8	50,8	3/8" UNC	2,75	315	37809	37810
	BKHP-DN20-SAE420	20	156	60	71	19	23,8	50,8	3/8" UNC	3,59	420	53481	53483
	BKH-DN25-SAE420	25	148	70	81	24	27,8	57,2	7/16" UNC	3,80	315	31772	37811
	BKHP-DN25-SAE420	25	165	70	81	24	27,8	57,2	7/16" UNC	5,03	420	53482	53484

Two-way



MHA ZENTGRAF

FlowControl Technology

2-way threaded
DN 4 to DN 50

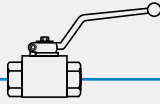

2-way SAEFS
DN 4 to DN 50

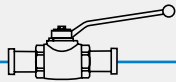

2-way flanged
DN 15 to DN 200

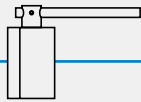

3- and 4-way
DN 6 to DN 40

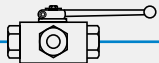

3-way selector
DN 6 to DN 50

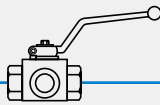

Combinations
DN 6 to DN 50

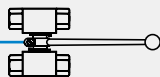

Intermediate
DN 13 to DN 50

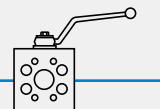

Manifold
DN 6 to DN 50

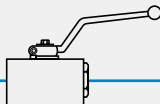

Flow control
DN 6 to DN 50

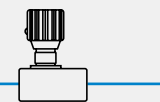

www.mha-zentgraf.com
info@mha-zentgraf.com

After a custom solution?
- Speak with us now!