

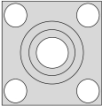

SQUARE FLANGES

Full Catalogue

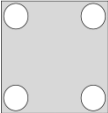
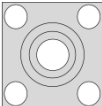
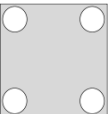
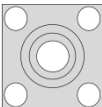
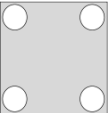
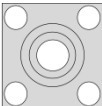
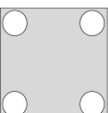

INDEX

Weld in Square Flange (210 kgf/cm ² SHA/SHB)		Page 4
Blind Square Flange (210 kgf/cm ² SHA/SHB)		Page 5
Weld in Square Flange (210 kgf/cm ² SSA/SSB)		Page 6
Blind Square Flange (210 kgf/cm ² SSA/SSB)		Page 7
Weld in Square Flange (280 kgf/cm ² KA/KB)		Page 8
Blind Square Flange (280 kgf/cm ² KA/KB)		Page 9
Weld in Square Flange (350 kgf/cm ² KA/KB)		Page 10
Blind Square Flange (350 kgf/cm ² KA/KB)		Page 11
Oring Groove & Dimension (210 kgf/cm ²)		Page 12
Oring Groove & Dimension (280 kgf/cm ² , 350 kgf/cm ²)		Page 13

Square Flanges

Specifications:

JIS B2291 - Socket Welding Pipe Flanges to be used for Pressures of 210 kgf/cm²

JIS F7806 - Socket Welding Pipe Flanges to be used for Pressures of 280 kgf/cm² and 350 kgf/cm²

Material Specifications:

SF440A Hydraulic Steel

SS316 Stainless Steel

Size Range:

SF440A Hydraulic Steel : 1/4" – 6"NB

SS316 Stainless Steel : 3/8" – 3"NB

Working Pressure:

SHA/SHB 210kgf/cm²

SSA/SSB 210kgf/cm²

KA/KB 280kgf/cm², 350kgf/cm²

LSA 210kgf/cm²

Flange Series:

SHA/SHB Square Flange using Hexagon Hex Bolts (Larger Flange Body)

SSA/SSB Square Flange using Socket Cap Screws (Smaller Flange Body)

KA/KB Square Flange using Hexagon Hex Bolts

LSA Square Flange using Socket Cap Screws

Flange Screws:

Metric screws according to DIN 912-8.8 (Standard)



SHAB

SSAB

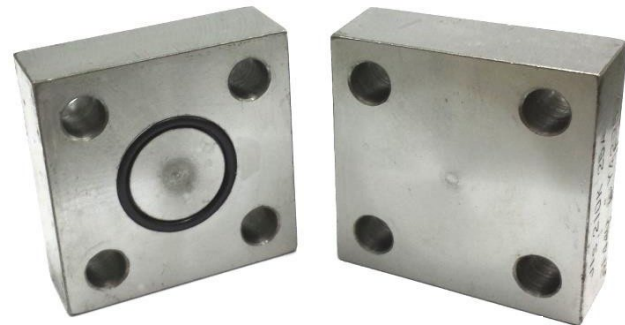

Oring and Flat Square Blind Flanges

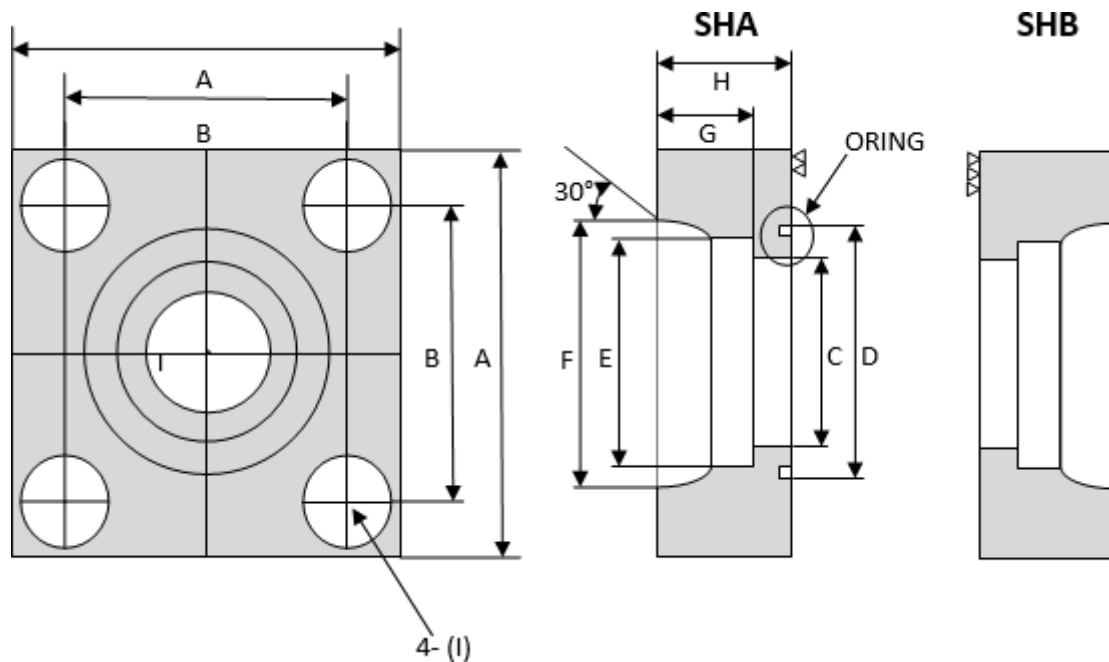

LSA Square Flange

WELD IN SQUARE FLANGES (210 KGF/CM² SHA/SHB)

SHA/SHB (210 KGF/CM²)

SIZE	ORING	PART NUMBER	DIMENSIONS									BOLT LENGTH (MINIMUM)	WEIGHT
			A	B	C	D	E	F	G	H	I		
8	G25	FL-SQ-H-SHAB-04	63	40	8.0	30	14.3	24	11	22	11	M10 x 55	1.30 KGS
10	G25	FL-SQ-H-SHAB-06	63	40	11.5	30	17.8	28	11	22	11	M10 x 55	1.30 KGS
15	G25	FL-SQ-H-SHAB-08	63	40	16.0	30	22.2	32	11	22	11	M10 x 55	1.40 KGS
20	G30	FL-SQ-H-SHAB-12	68	45	20.0	35	27.7	38	12	22	11	M10 x 55	1.50 KGS
25	G35	FL-SQ-H-SHAB-16	80	53	25.0	40	34.5	45	14	28	13	M12 x 70	2.60 KGS
32	G40	FL-SQ-H-SHAB-20	90	63	31.5	45	43.2	56	16	28	13	M12 x 70	3.15 KGS
40	G50	FL-SQ-H-SHAB-24	100	70	37.5	55	49.1	63	18	36	18	M16 x 90	5.10 KGS
50	G60	FL-SQ-H-SHAB-32	112	80	47.5	65	61.1	75	20	36	18	M16 x 90	5.90 KGS
65	G75	FL-SQ-H-SHAB-40	140	100	60.0	80	77.1	95	22	45	22	M20 x 110	11.40 KGS
80	G85	FL-SQ-H-SHAB-48	155	112	71.0	90	90.0	108	25	45	24	M22 x 120	14.10 KGS
100	G105	FL-SQ-H-SHAB-64	190	140	87.3	110	115.4	135	28	60	27	M24 x 140	25.50 KGS
125	G130	FL-SQ-H-SHAB-80	230	168	120.8	135	141.2	164	30	65	32	M30 x 170	41.00 KGS
150	G155	FL-SQ-H-SHAB-96	270	195	128.8	165	166.9	193	35	80	39	M36 x 190	68.50 KGS

Designation for Order:

 Double Flanges, SHAB
 (Flat side & Oring side)

SF440A	FL-SQ-H...SHAB..
SS316	FL-SQ-S...SHAB..

 Counter-Flanges, SHA
 (Oring side)

SF440A	FL-SQ-H...SHA..
SS316	FL-SQ-S...SHA..

 Flanges, SHB
 (Flat side)

SF440A	FL-SQ-H...SHB..
SS316	FL-SQ-S...SHB..

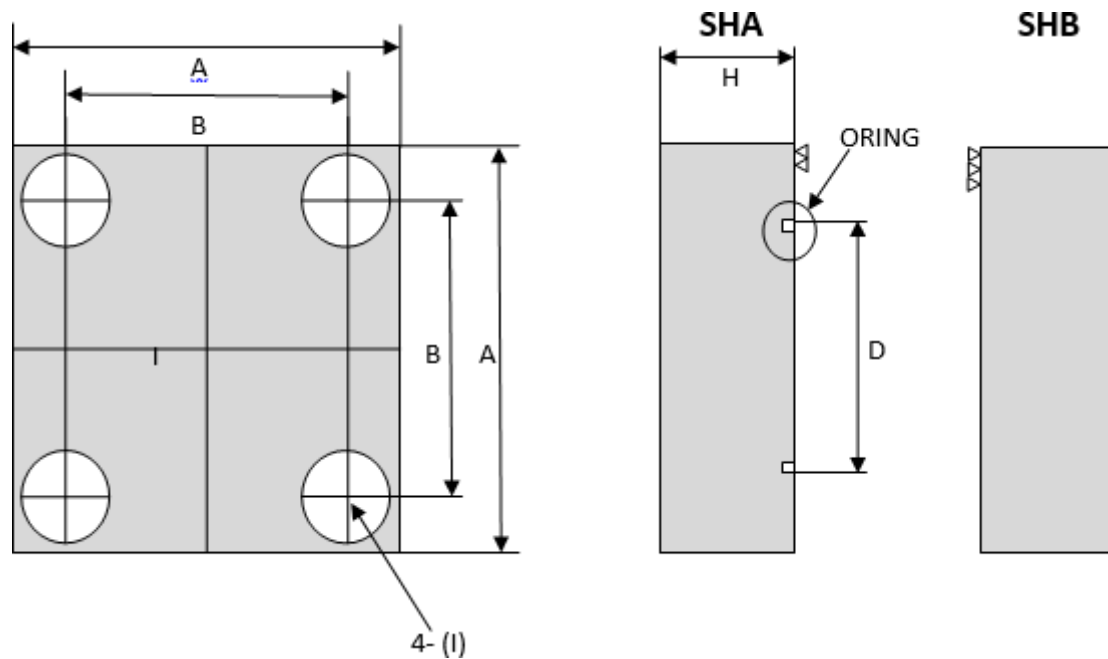
BLIND SQUARE FLANGES (210 KGF/CM² SHA/SHB)

SHA/SHB (210 KGF/CM²)

SIZE	ORING	PART NUMBER (ORING SIDE)	PART NUMBER (FLAT SIDE)	DIMENSIONS						
				A	B	D	H	I	BOLT LENGTH (MINIMUM)	WEIGHT
8	G25	FL-SQ-H-SHA-BL-04	FL-SQ-H-SHB-BL-04	63	40	30	22	11	M10 x 55	1.30 KGS
10	G25	FL-SQ-H-SHA-BL-06	FL-SQ-H-SHB-BL-06	63	40	30	22	11	M10 x 55	1.30 KGS
15	G25	FL-SQ-H-SHA-BL-08	FL-SQ-H-SHB-BL-08	63	40	30	22	11	M10 x 55	1.40 KGS
20	G30	FL-SQ-H-SHA-BL-12	FL-SQ-H-SHB-BL-12	68	45	35	22	11	M10 x 55	1.50 KGS
25	G35	FL-SQ-H-SHA-BL-16	FL-SQ-H-SHB-BL-16	80	53	40	28	13	M12 x 70	2.60 KGS
32	G40	FL-SQ-H-SHA-BL-20	FL-SQ-H-SHB-BL-20	90	63	45	28	13	M12 x 70	3.15 KGS
40	G50	FL-SQ-H-SHA-BL-24	FL-SQ-H-SHB-BL-24	100	70	55	36	18	M16 x 90	5.10 KGS
50	G60	FL-SQ-H-SHA-BL-32	FL-SQ-H-SHB-BL-32	112	80	65	36	18	M16 x 90	5.90 KGS
65	G75	FL-SQ-H-SHA-BL-40	FL-SQ-H-SHB-BL-40	140	100	80	45	22	M20 x 110	11.40 KGS
80	G85	FL-SQ-H-SHA-BL-48	FL-SQ-H-SHB-BL-48	155	112	90	45	24	M22 x 120	14.10 KGS
100	G105	FL-SQ-H-SHA-BL-64	FL-SQ-H-SHB-BL-64	190	140	110	60	27	M24 x 140	25.50 KGS
125	G130	FL-SQ-H-SHA-BL-80	FL-SQ-H-SHB-BL-80	230	168	135	65	32	M30 x 170	41.00 KGS
150	G155	FL-SQ-H-SHA-BL-96	FL-SQ-H-SHB-BL-96	270	195	165	80	39	M36 x 190	68.50 KGS

Designation for Order:

Counter-Flanges, SHA

(Oring side)

SF440A	FL-SQ-H...SHA-BL..
SS316	FL-SQ-S...SHA-BL..

Flanges, SHB

(Flat side)

SF440A	FL-SQ-H...SHB-BL..
SS316	FL-SQ-S...SHB-BL..

WELD IN SQUARE FLANGES (210 KGF/CM² SSA/SSB)

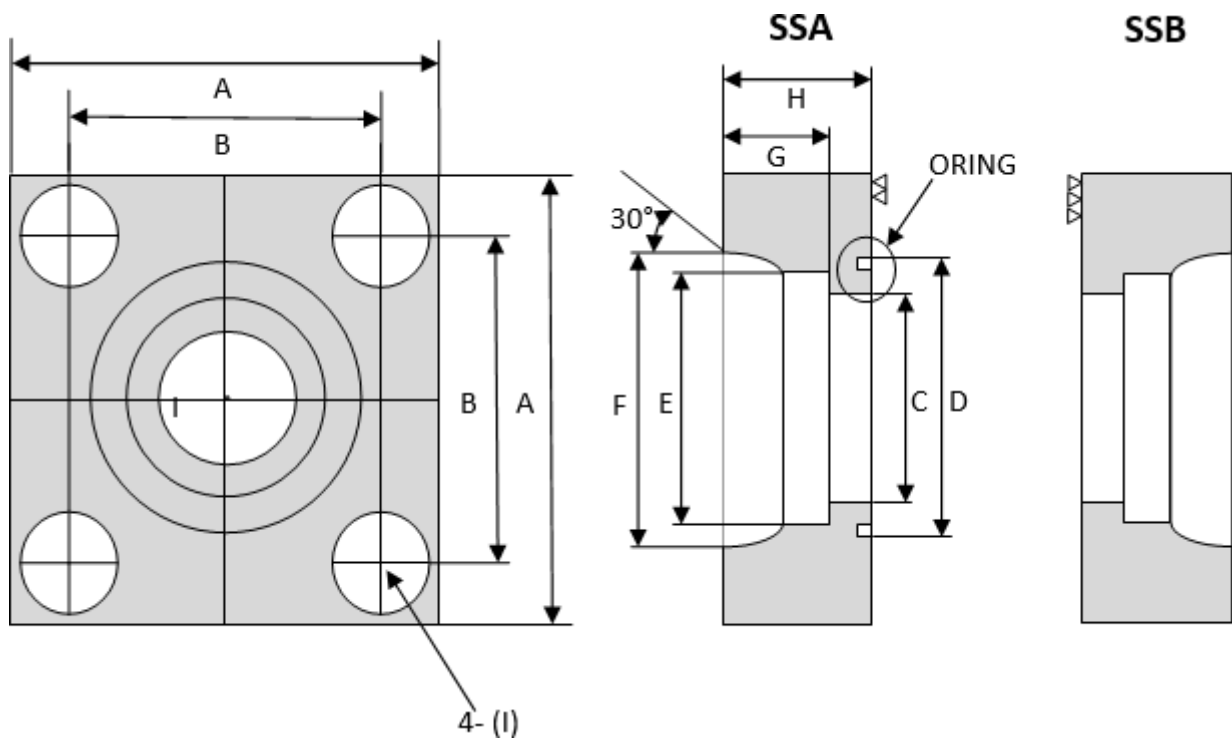

SSA/SSB (210 KGF/CM²)

SIZE	ORING	PART NUMBER	DIMENSIONS									BOLT LENGTH (MINIMUM)	WEIGHT
			A	B	C	D	E	F	G	H	I		
10	G25	FL-SQ-H-SSAB-06	54	36	11.5	30	17.8	28	11	22	11	M10 x 40	1.00 KGS
15	G25	FL-SQ-H-SSAB-08	54	36	16.0	30	22.2	32	11	22	11	M10 x 40	1.00 KGS
20	G30	FL-SQ-H-SSAB-12	58	40	20.0	35	27.7	38	12	22	11	M10 x 40	1.20 KGS
25	G35	FL-SQ-H-SSAB-16	68	48	25.0	40	34.5	45	14	28	13	M12 x 50	1.60 KGS
32	G40	FL-SQ-H-SSAB-20	76	56	31.5	45	43.2	56	16	28	13	M12 x 50	2.00 KGS
40	G50	FL-SQ-H-SSAB-24	92	65	37.5	55	49.1	63	18	36	18	M16 x 65	3.80 KGS
50	G60	FL-SQ-H-SSAB-32	100	73	47.5	65	61.1	75	20	36	18	M16 x 65	4.00 KGS
65	G75	FL-SQ-H-SSAB-40	128	92	60.0	80	77.1	95	22	45	22	M20 x 85	8.20 KGS
80	G85	FL-SQ-H-SSAB-48	140	103	71.0	90	90.0	108	25	45	24	M22 x 85	9.40 KGS

Designation for Order:

Double Flanges, SSAB
 (Flat side & Oring side)

SF440A	FL-SQ-H...SSAB..
SS316	FL-SQ-S...SSAB..

Counter-Flanges, SSA
 (Oring side)

SF440A	FL-SQ-H...SSA..
SS316	FL-SQ-S...SSA..

Flanges, SSB
 (Flat side)

SF440A	FL-SQ-H...SSB..
SS316	FL-SQ-S...SSB..

BLIND SQUARE FLANGES (210 KGF/CM² SSA/SSB)

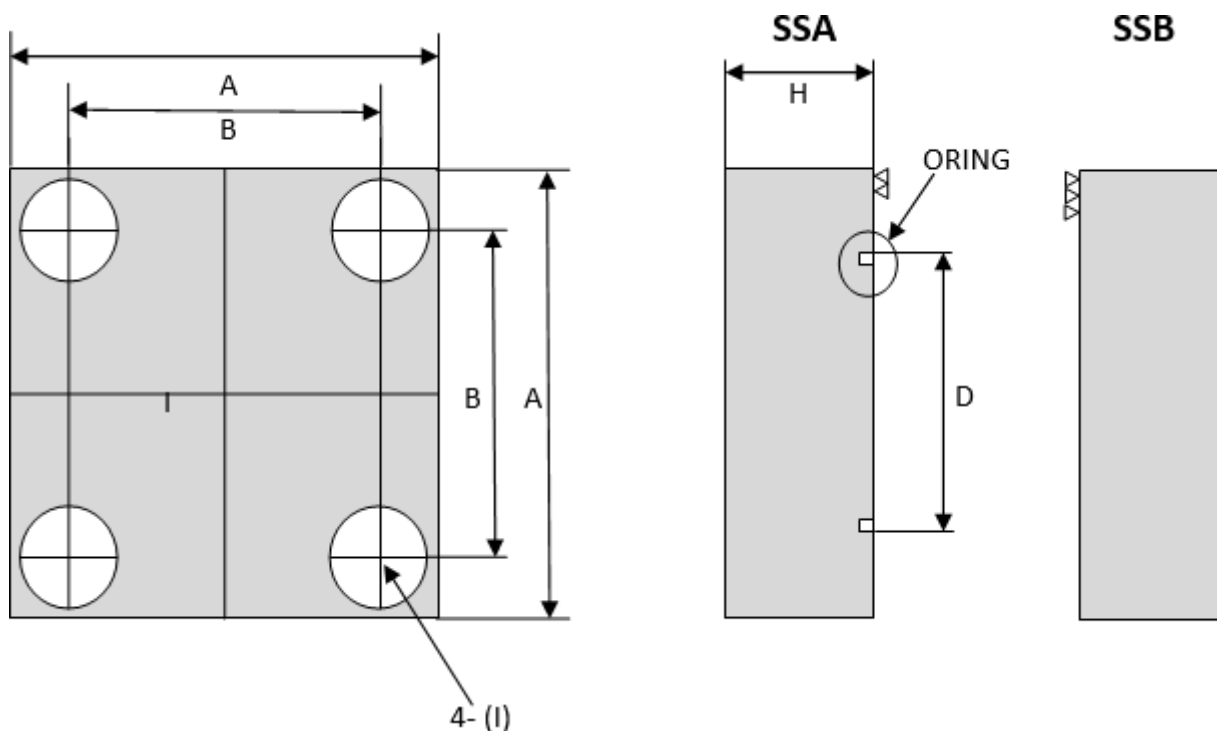

SSA/SSB (210 KGF/CM²)

SIZE	ORING	PART NUMBER (ORING SIDE)	PART NUMBER (FLAT SIDE)	DIMENSIONS						
				A	B	D	H	I	BOLT LENGTH (MINIMUM)	WEIGHT
10	G25	FL-SQ-H-SSA-BL-06	FL-SQ-H-SSB-BL-06	54	36	30	22	11	M10 x 40	1.00 KGS
15	G25	FL-SQ-H-SSA-BL-08	FL-SQ-H-SSB-BL-08	54	36	30	22	11	M10 x 40	1.00 KGS
20	G30	FL-SQ-H-SSA-BL-12	FL-SQ-H-SSB-BL-12	58	40	35	22	11	M10 x 40	1.20 KGS
25	G35	FL-SQ-H-SSA-BL-16	FL-SQ-H-SSB-BL-16	68	48	40	28	13	M12 x 50	1.60 KGS
32	G40	FL-SQ-H-SSA-BL-20	FL-SQ-H-SSB-BL-20	76	56	45	28	13	M12 x 50	2.00 KGS
40	G50	FL-SQ-H-SSA-BL-24	FL-SQ-H-SSB-BL-24	92	65	55	36	18	M16 x 65	3.80 KGS
50	G60	FL-SQ-H-SSA-BL-32	FL-SQ-H-SSB-BL-32	100	73	65	36	18	M16 x 65	4.00 KGS
65	G75	FL-SQ-H-SSA-BL-40	FL-SQ-H-SSB-BL-40	128	92	80	45	22	M20 x 85	8.20 KGS
80	G85	FL-SQ-H-SSA-BL-48	FL-SQ-H-SSB-BL-48	140	103	90	45	24	M22 x 85	9.40 KGS

Designation for Order:

Counter-Flanges, SSA
 (Oring side)

SF440A	FL-SQ-H...SSA-BL..
SS316	FL-SQ-S...SSA-BL..

Flanges, SSB
 (Flat side)

SF440A	FL-SQ-H...SSB-BL..
SS316	FL-SQ-S...SSB-BL..

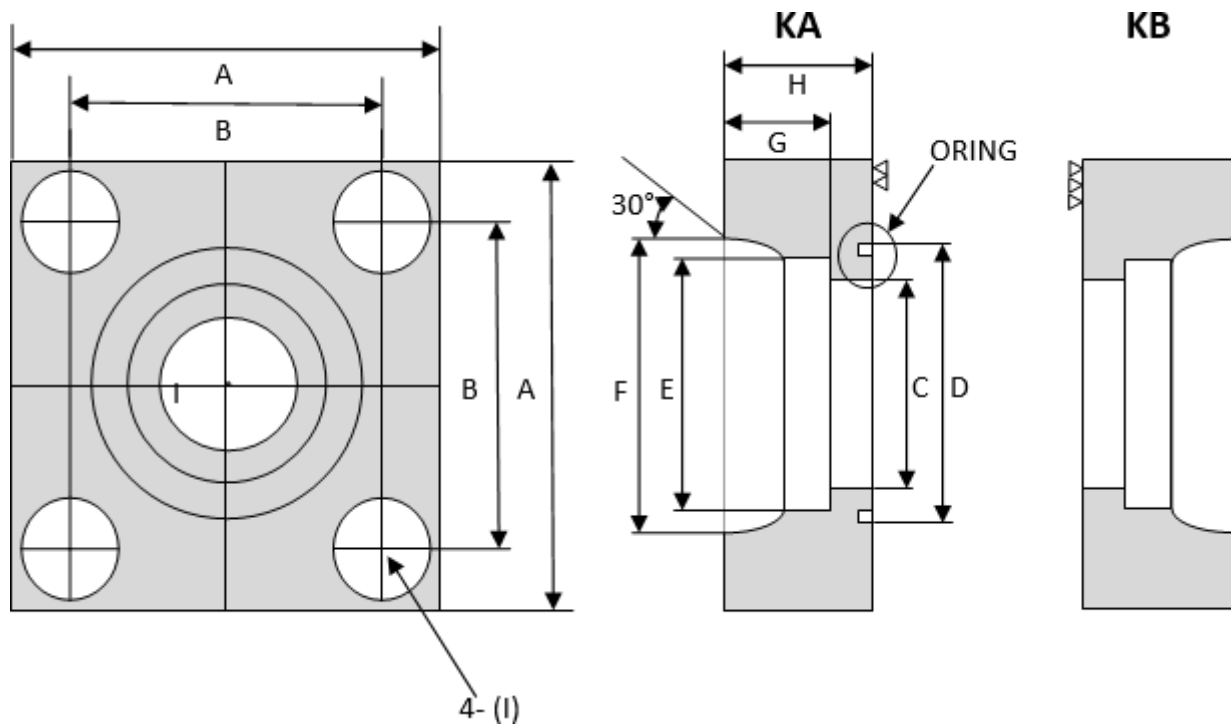
WELD IN SQUARE FLANGES (280 KGF/CM² KA/KB)

KA/KB (280 KGF/CM²)

SIZE	ORING	PART NUMBER	DIMENSIONS									BOLT LENGTH (MINIMUM)	WEIGHT
			A	B	C	D	E	F	G	H	I		
15	P20	FL-SQ-H-KAB-280-08	66	43	12.3	24	22.2	34	12	22	11.0	M10 x 55	1.26 KGS
20	G25	FL-SQ-H-KAB-280-12	72	48	16.2	30	27.7	40	12	25	11.0	M10 x 70	1.70 KGS
25	G30	FL-SQ-H-KAB-280-16	85	58	21.2	35	34.5	48	14	35	13.5	M12 x 90	3.28 KGS
32	G40	FL-SQ-H-KAB-280-20	98	68	29.9	45	43.2	60	18	35	17.5	M16 x 90	4.06 KGS
40	G45	FL-SQ-H-KAB-280-24	105	74	34.4	50	49.1	66	20	40	17.5	M16 x 100	5.32 KGS
50	G55	FL-SQ-H-KAB-280-32	130	90	43.1	60	61.1	79	20	50	22.0	M20 x 120	10.28 KGS
65	G70	FL-SQ-H-KAB-280-40	150	108	57.3	75	77.1	100	25	60	24.0	M22 x 140	15.90 KGS
80	G80	FL-SQ-H-KAB-280-48	170	120	66.9	85	90.0	114	25	65	26.0	M24 x 160	22.00 KGS

Designation for Order:

 Double Flanges, KAB
 (Flat side & Oring side)

SF440A	FL-SQ-H...KAB..
SS316	FL-SQ-S...KAB..

 Counter-Flanges, KA
 (Oring side)

SF440A	FL-SQ-H...KA..
SS316	FL-SQ-S...KA..

 Flanges, KB
 (Flat side)

SF440A	FL-SQ-H...KB..
SS316	FL-SQ-S...KB..

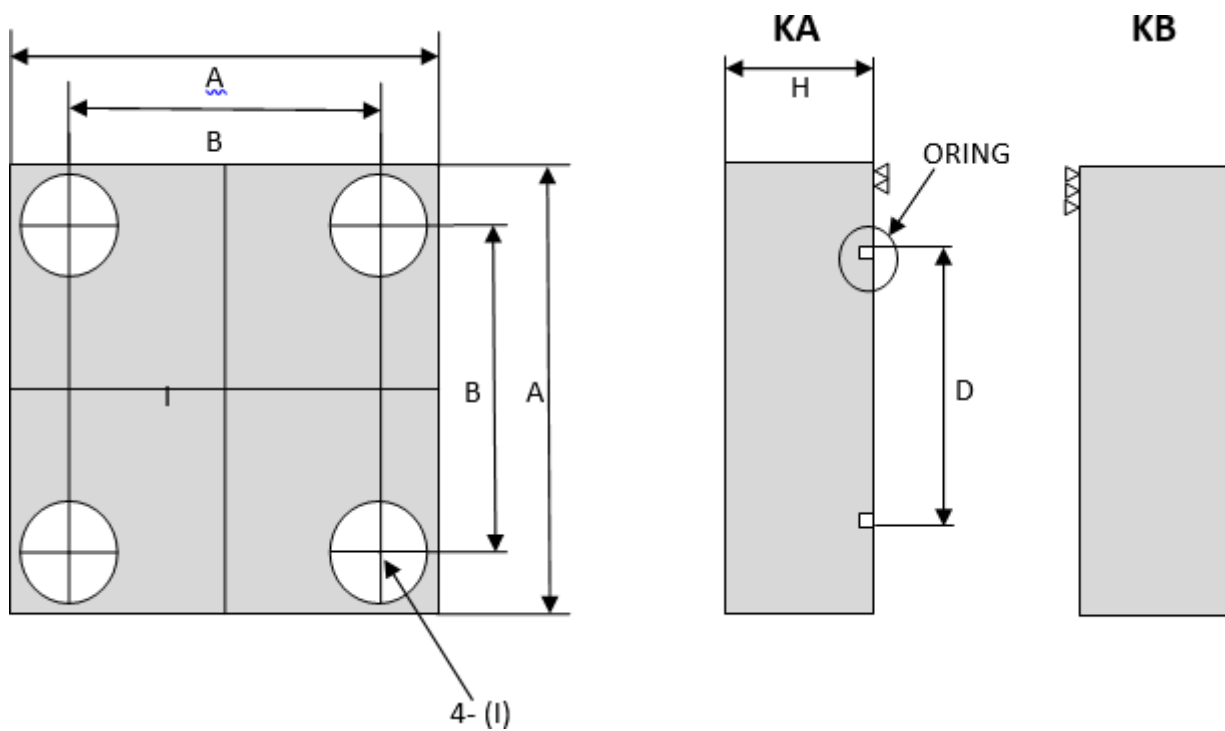
BLIND SQUARE FLANGES (280 KGF/CM² KA/KB)

KA/KB (280 KGF/CM²)

SIZE	ORING	PART NUMBER (ORING SIDE)	PART NUMBER (FLAT SIDE)	DIMENSIONS						
				A	B	D	H	I	BOLT LENGTH (MINIMUM)	WEIGHT
15	P20	FL-SQ-H-KA-BL-280-08	FL-SQ-H-KB-BL-280-08	66	43	24	22	11.0	M10 x 55	1.26 KGS
20	G25	FL-SQ-H-KA-BL-280-12	FL-SQ-H-KB-BL-280-12	72	48	30	25	11.0	M10 x 70	1.70 KGS
25	G30	FL-SQ-H-KA-BL-280-16	FL-SQ-H-KB-BL-280-16	85	58	35	35	13.5	M12 x 90	3.28 KGS
32	G40	FL-SQ-H-KA-BL-280-20	FL-SQ-H-KB-BL-280-20	98	68	45	35	17.5	M16 x 90	4.06 KGS
40	G45	FL-SQ-H-KA-BL-280-24	FL-SQ-H-KB-BL-280-24	105	74	50	40	17.5	M16 x 100	5.32 KGS
50	G55	FL-SQ-H-KA-BL-280-32	FL-SQ-H-KB-BL-280-32	130	90	60	50	22.0	M20 x 120	10.28 KGS
65	G70	FL-SQ-H-KA-BL-280-40	FL-SQ-H-KB-BL-280-40	150	108	75	60	24.0	M22 x 140	15.90 KGS
80	G80	FL-SQ-H-KA-BL-280-48	FL-SQ-H-KB-BL-280-48	170	120	85	65	26.0	M24 x 160	22.00 KGS

Designation for Order:

 Counter-Flanges, KA
 (Oring side)

SF440A	FL-SQ-H...KA-BL..
SS316	FL-SQ-S...KA-BL..

 Flanges, KB
 (Flat side)

SF440A	FL-SQ-H...KB-BL..
SS316	FL-SQ-S...KB-BL..

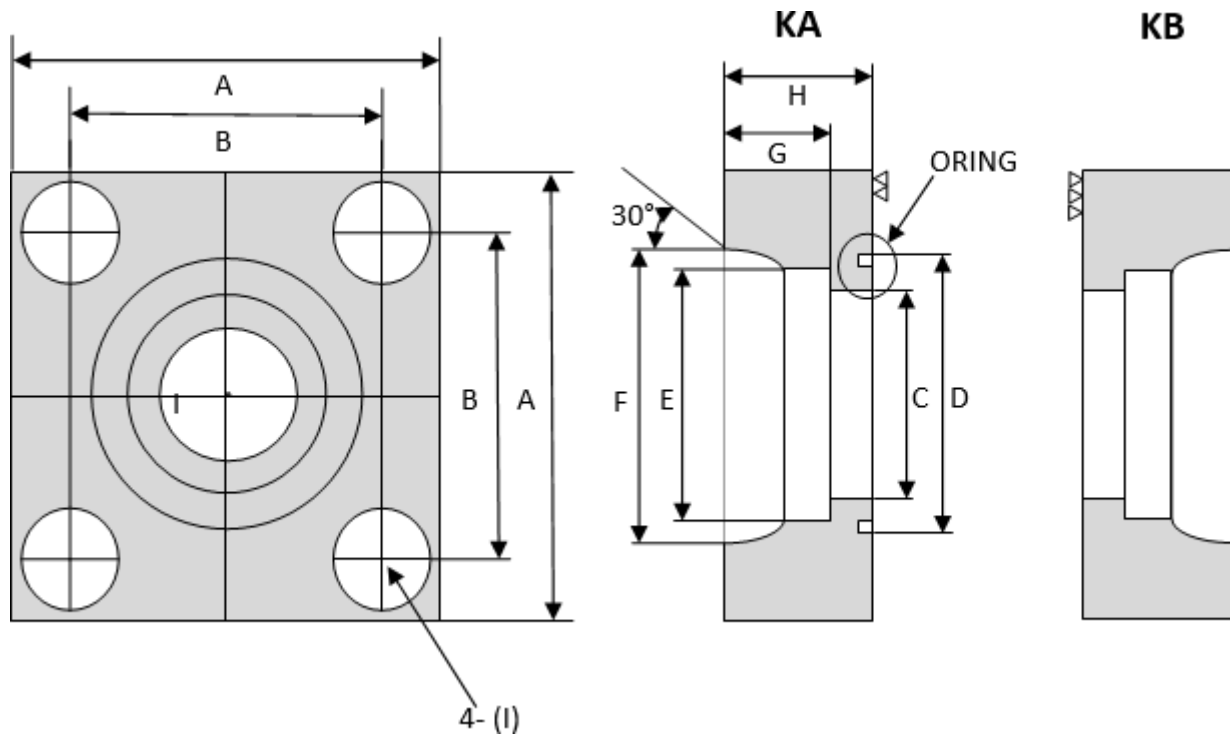
WELD IN SQUARE FLANGES (350 KGF/CM² KA/KB)

KAB (350 KGF/CM²)

SIZE	ORING	PART NUMBER	DIMENSIONS									BOLT LENGTH (MINIMUM)	WEIGHT
			A	B	C	D	E	F	G	H	I		
15	P20	FL-SQ-H-KAB-350-08	68	45	12.3	24	22.2	37.5	12	28	11.0	M10 x 70	1.76 KGS
20	G25	FL-SQ-H-KAB-350-12	82	55	16.2	30	27.7	43.5	12	30	13.5	M12 x 80	2.68 KGS
25	G30	FL-SQ-H-KAB-350-16	95	65	21.2	35	34.5	53.0	14	35	17.5	M16 x 90	4.04 KGS
32	G35	FL-SQ-H-KAB-350-20	100	70	23.3	40	43.2	63.0	18	35	17.5	M16 x 90	4.32 KGS
40	G40	FL-SQ-H-KAB-350-24	105	75	28.2	45	49.1	70.0	20	42	17.5	M16 x 100	5.68 KGS
50	G50	FL-SQ-H-KAB-350-32	132	92	38.3	55	61.1	84.0	25	50	22.0	M20 x 120	10.60 KGS
65	G60	FL-SQ-H-KAB-350-40	160	112	48.3	65	77.1	105.0	30	60	26.0	M24 x 160	19.84 KGS
80	G70	FL-SQ-H-KAB-350-48	190	130	58.7	75	90.0	120.0	30	68	33.0	M30 x 170	29.60 KGS

Designation for Order:

 Double Flanges, KAB
 (Flat side & Oring side)

SF440A	FL-SQ-H...KAB..
SS316	FL-SQ-S...KAB..

 Counter-Flanges, KA
 (Oring side)

SF440A	FL-SQ-H...KA..
SS316	FL-SQ-S...KA..

 Flanges, KB
 (Flat side)

SF440A	FL-SQ-H...KB..
SS316	FL-SQ-S...KB..

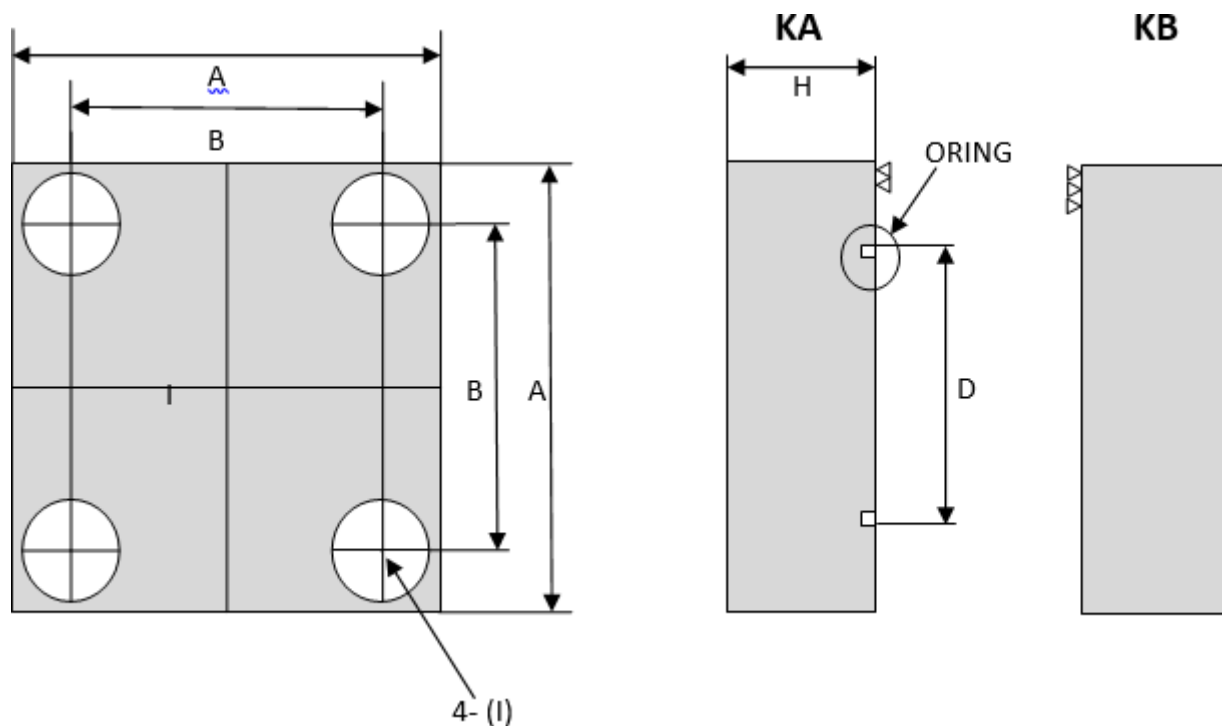
BLIND SQUARE FLANGES (350 KGF/CM² KA/KB)

KA/KB (350 KGF/CM²)

SIZE	ORING	PART NUMBER (ORING SIDE)	PART NUMBER (FLAT SIDE)	DIMENSIONS						
				A	B	D	H	I	BOLT LENGTH (MINIMUM)	WEIGHT
15	P20	FL-SQ-H-KA-BL-350-08	FL-SQ-H-KB-BL-350-08	68	45	24	28	11.0	M10 x 70	1.76 KGS
20	G25	FL-SQ-H-KA-BL-350-12	FL-SQ-H-KB-BL-350-12	82	55	30	30	13.5	M12 x 80	2.68 KGS
25	G30	FL-SQ-H-KA-BL-350-16	FL-SQ-H-KB-BL-350-16	95	65	35	35	17.5	M16 x 90	4.04 KGS
32	G35	FL-SQ-H-KA-BL-350-20	FL-SQ-H-KB-BL-350-20	100	70	40	35	17.5	M16 x 90	4.32 KGS
40	G40	FL-SQ-H-KA-BL-350-24	FL-SQ-H-KB-BL-350-24	105	75	45	42	17.5	M16 x 100	5.68 KGS
50	G50	FL-SQ-H-KA-BL-350-32	FL-SQ-H-KB-BL-350-32	132	92	55	50	22.0	M20 x 120	10.60 KGS
65	G60	FL-SQ-H-KA-BL-350-40	FL-SQ-H-KB-BL-350-40	160	112	65	60	26.0	M24 x 160	19.84 KGS
80	G70	FL-SQ-H-KA-BL-350-48	FL-SQ-H-KB-BL-350-48	190	130	75	68	33.0	M30 x 170	29.60 KGS

Designation for Order:

 Counter-Flanges, KA
 (Oring side)

SF440A	FL-SQ-H...KA-BL..
SS316	FL-SQ-S...KA-BL..

 Flanges, KB
 (Flat side)

SF440A	FL-SQ-H...KB-BL..
SS316	FL-SQ-S...KB-BL..

LSA SQUARE FLANGE 210KGF/CM²

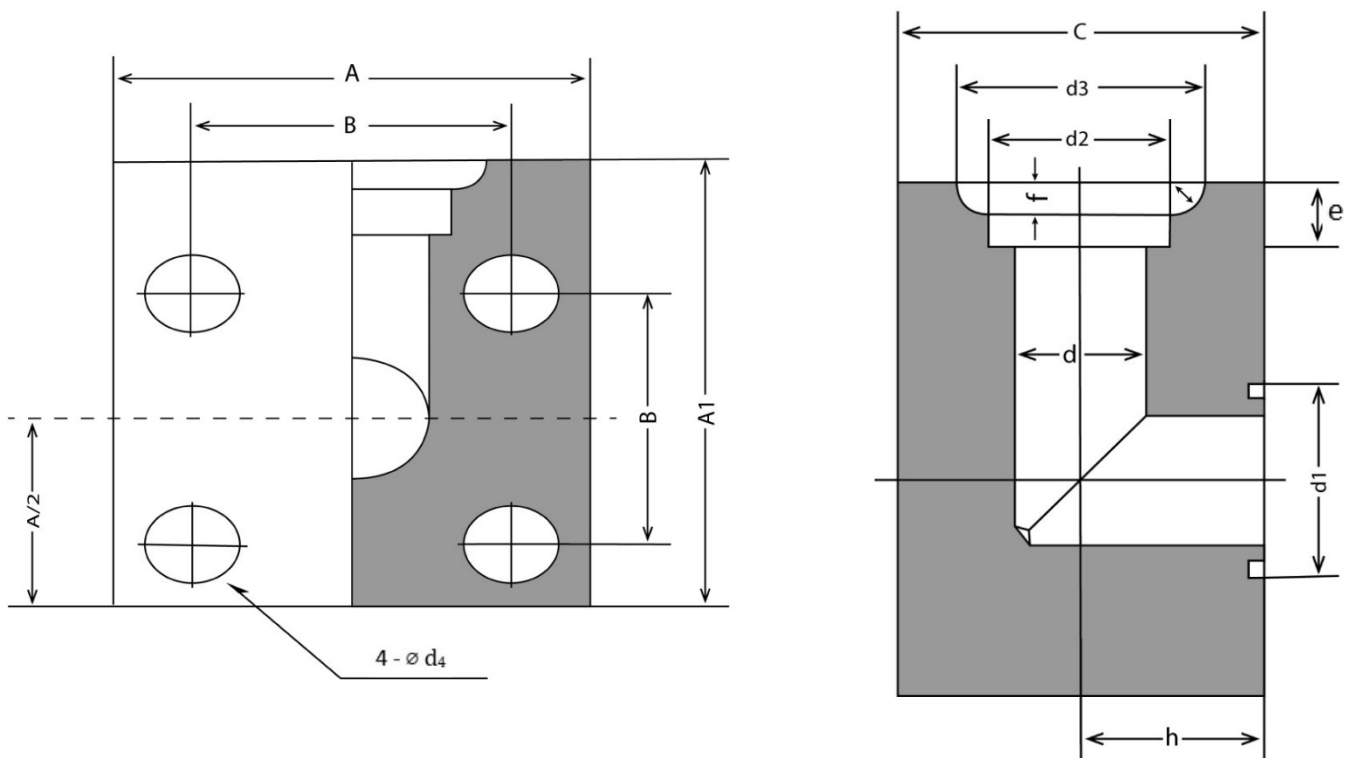

LSA (210KGF/CM²)

SIZE	ORING	PART NUMBER	DIMENSIONS													BOLT LENGTH (MINIMUM)	WEIGHT
			A	A1	B	C	h	d	d1	d2	e	d3	d4	f	r		
15	15A	FL-SQ-H-LSA-0-08	54	63	36	40	20	16	30	22.2	11	32	11	3.5	5	M10 x 55	0.85 KGS
20	20A	FL-SQ-H-LSA-0-12	58	70	40	45	22.5	20	35	27.7	12	38	11	4	5	M10 x 60	1.11 KGS
25	25A	FL-SQ-H-LSA-0-16	68	82	48	50	25	25	40	34.5	14	45	13	4	5	M12 x 70	1.64 KGS
32	32A	FL-SQ-H-LSA-0-20	76	92	56	63	31.5	31.5	45	43.2	16	56	13	6	5	M12 x 85	2.56 KGS
40	40A	FL-SQ-H-LSA-0-24	92	110	65	71	35.5	37.5	55	49.1	18	63	18	7	5	M16 x 100	4.11 KGS
50	50A	FL-SQ-H-LSA-0-32	100	125	73	85	42.5	47.5	65	61.1	20	75	18	7	5	M16 x 115	5.93 KGS
65	65A	FL-SQ-H-LSA-0-40	128	150	92	106	53	60	80	77.1	22	95	22	9.5	6	M20 x 145	11.42 KGS
80	80A	FL-SQ-H-LSA-0-48	140	170	103	118	59	71	90	90	25	108	24	11	6	M22 x 160	15.25 KGS

Designation for Order:

Flanges,
 (Oring-side)

SF440A | FL-SQ-H-LSA-0...

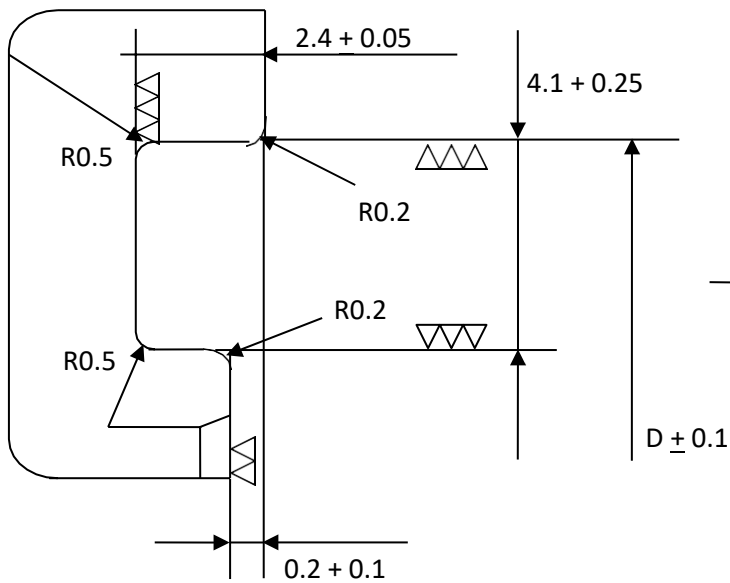
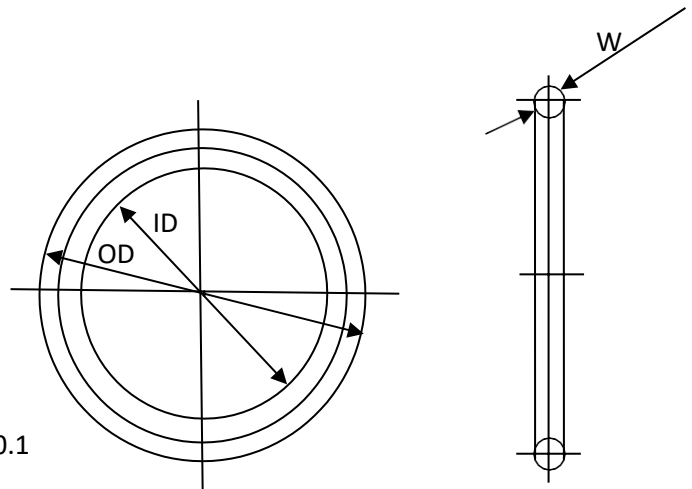
ORING GROOVE & ORING DIMENSION FOR 210 KGF/CM² SQUARE FLANGES
ORING GROOVE

ORING

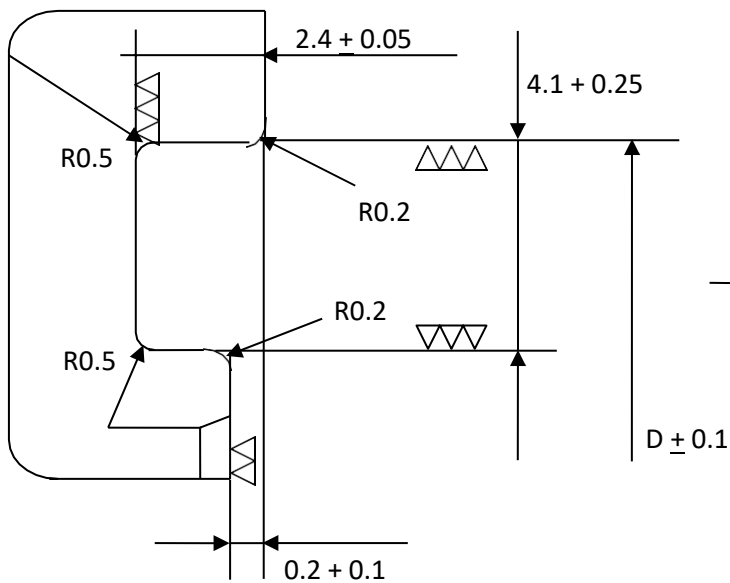
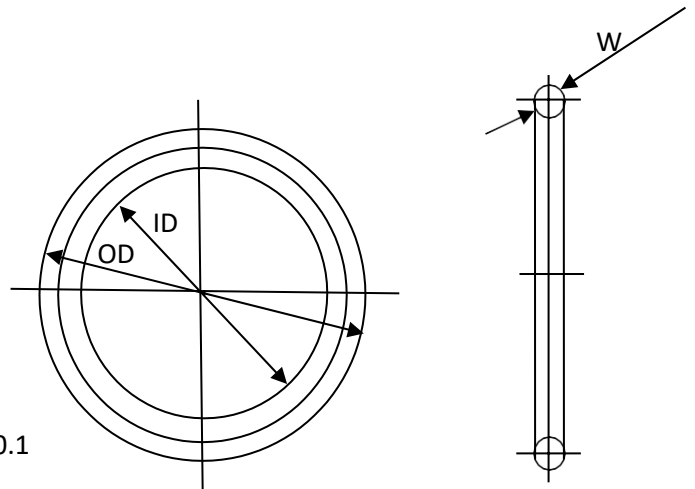
SHAB & SSAB (210 KGF/CM²) ORING DIMENSION

SIZE	INCH	PART NUMBER	DIMENSIONS		
			OD	ID	W
8	1/4"	G25	30.60	24.40	3.1
10	3/8"	G25	30.60	24.40	3.1
15	1/2"	G25	30.60	24.40	3.1
20	3/4"	G30	35.60	29.40	3.1
25	1"	G35	40.60	34.40	3.1
32	1 1/4"	G40	45.60	39.40	3.1
40	1 1/2"	G50	55.60	49.40	3.1
50	2"	G60	65.60	59.40	3.1
65	2 1/2"	G75	80.60	74.40	3.1
80	3"	G85	90.60	84.40	3.1
100	4"	G105	110.60	104.40	3.1
125	5"	G130	135.60	129.40	3.1
150	6"	G155	165.70	154.30	5.7

ORING GROOVE & ORING DIMENSION FOR 280 KGF/CM², 350 KGF/CM² SQUARE FLANGES
ORING GROOVE

ORING

KAB (280 KGF/CM²) ORING DIMENSION

SIZE	INCH	PART NUMBER	DIMENSIONS		
			OD	ID	W
15	1/2"	P20	24.60	19.80	2.40
20	3/4"	G25	30.60	24.40	3.10
25	1"	G30	35.60	29.40	3.10
32	1 1/4"	G40	45.60	39.40	3.10
40	1 1/2"	G45	50.60	44.40	3.10
50	2"	G55	60.60	54.40	3.10
65	2 1/2"	G70	75.60	69.40	3.10
80	3"	G80	85.60	79.40	3.10

KAB (350 KGF/CM²) ORING DIMENSION

SIZE	INCH	PART NUMBER	DIMENSIONS		
			OD	ID	W
15	1/2"	P20	24.60	19.80	2.40
20	3/4"	G25	30.60	24.40	3.10
25	1"	G30	35.60	29.40	3.10
32	1 1/4"	G35	40.60	34.40	3.10
40	1 1/2"	G40	45.60	39.40	3.10
50	2"	G50	55.60	49.40	3.10
65	2 1/2"	G60	65.60	59.40	3.10
80	3"	G70	75.60	69.40	3.10

Chuan Kok Hardware & Machinery Pte Ltd

Address : 1783 Geylang Bahru, #01-02, Singapore 339708
Telephone Number : +65 6294 2566
Email Address : info@chuankok.com
Website : www.chuankok.com
Business Registration Number : 198201577Z
Country of Registration : Singapore

Conditions of Use of Catalogue:

The information in the catalogue are not binding and in order to improve distribution, Chuan Kok Hardware & Machinery Pte Ltd reserves the right to make any change including size and pressure ratings considered necessary at any time and without prior notice. According to the copyright and the civil law, any reproduction (also partial) of figures and texts of this catalogue by means of electronic, mechanical, photocopies, microfilms, recordings or other is forbidden without Chuan Kok Hardware & Machinery Pte Ltd's authorization.
Catalogue Version: 2021

